



These materials and the subsequent discussion are not an offer for sale of any securities of China Hongqiao Group Limited (the “Company”). The distribution of these materials in certain jurisdictions may be restricted by law and therefore persons into whose possession of these should inform themselves about and observe any such restrictions. Any failure to comply with these restrictions may constitute a violation of the securities laws of such jurisdiction.

Certain financial information contained herein has not been audited, comforted, confirmed or otherwise covered by a report by independent accountants. In addition, past performance of the Company cannot be relied on as a guide to future performance.

These materials and the subsequent discussion contain statements about future events, projections, forecasts and expectations that are forward-looking statements. Any statement in these materials that is not a statement of historical fact is a forward-looking statement that involves known and unknown risks, uncertainties and other factors which may cause our actual results, performance or achievements to be materially different from any future results, performance or achievements expressed or implied by such forward-looking statements. The Company makes no representation on the accuracy and completeness of any of the forward-looking statements, and, except as may be required by applicable law, assumes no obligations to supplement, amend, update or revise any such statements or any opinion expressed to reflect actual results, changes in assumptions or in the Company’s expectations, or changes in factors affecting these statements. Accordingly, any reliance you place on such forward-looking statements will be at your sole risk.



1.

2.

3.

4.

5.

6.



2



2011 3 24

* 356



* 2011 8 12



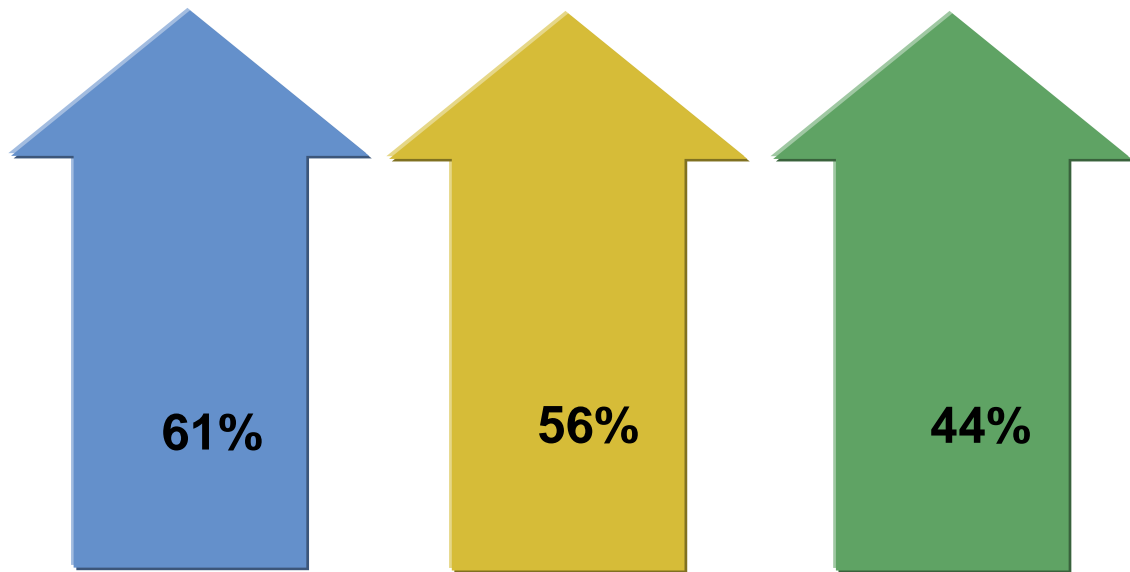

2011 6 30

()

1	456.0
2	213.5
3	180.0
4	148.1
5	90.0
6	85.0
7	84.0
8	80.0



1.

2.

3.

4.

5.

6.



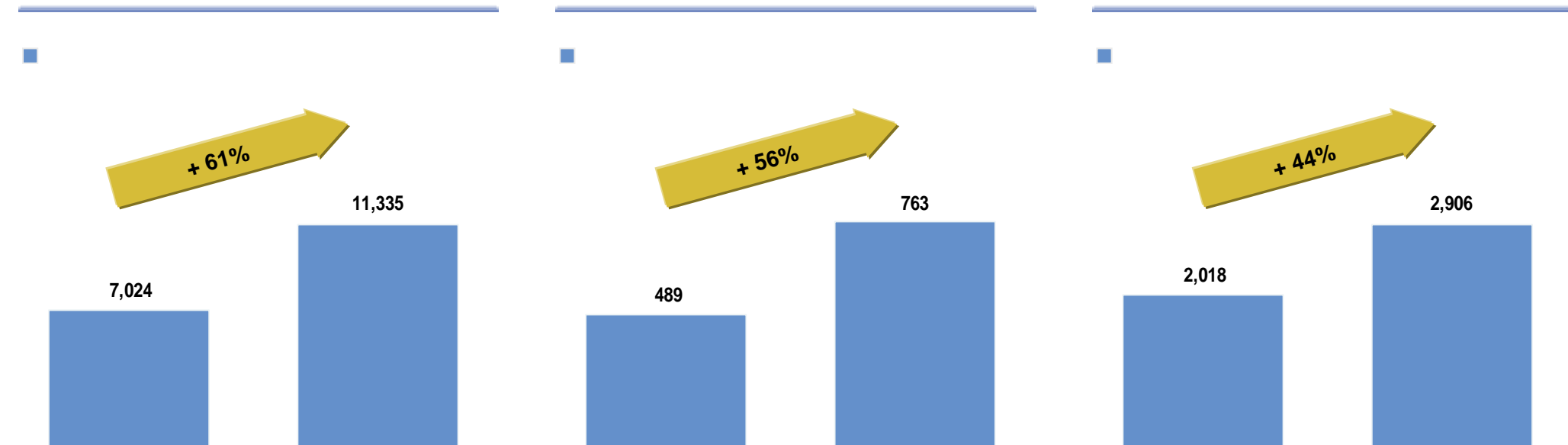

1

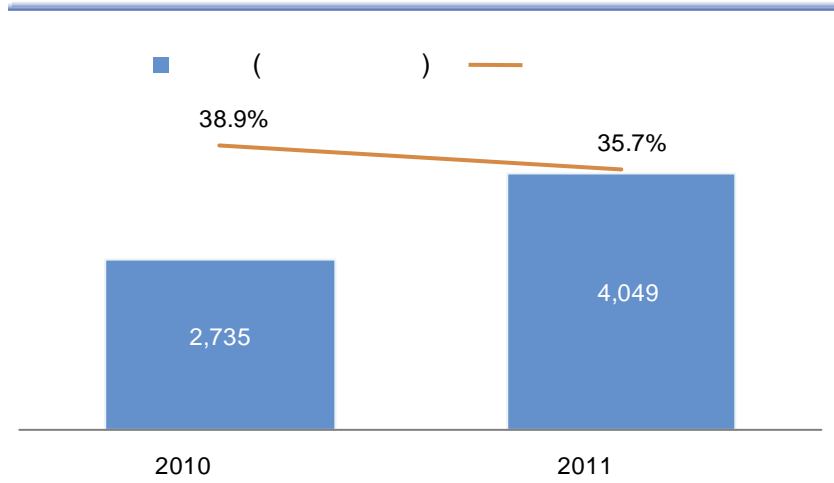

(EBITDA)¹

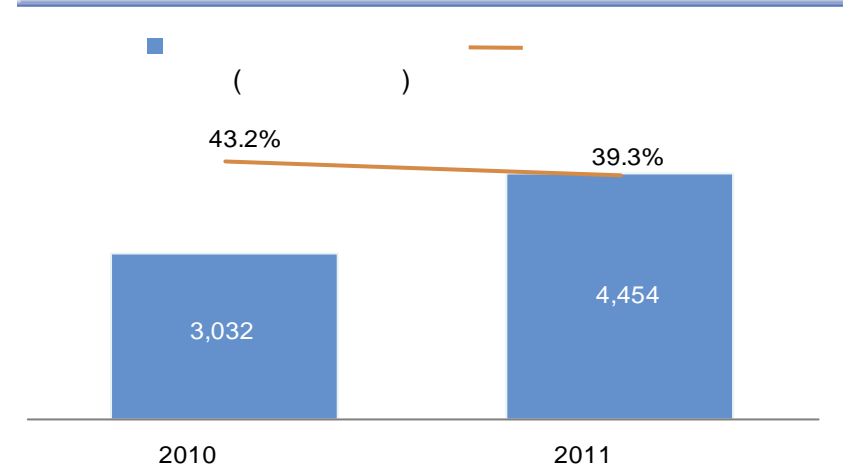

(EBIT)¹

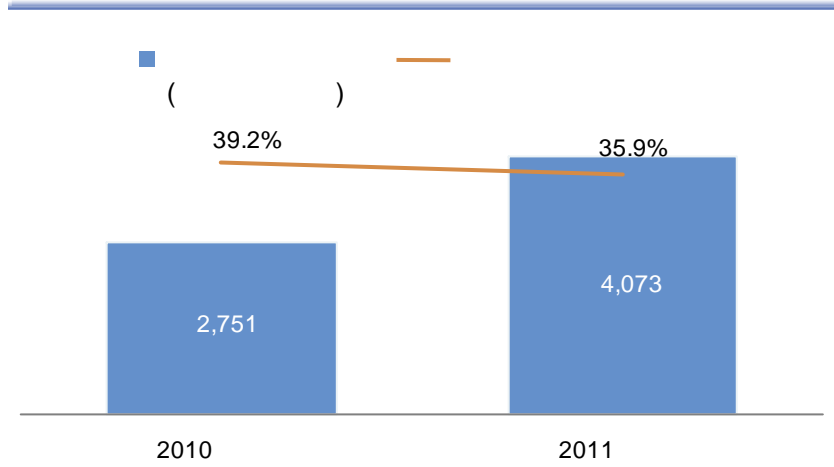

1

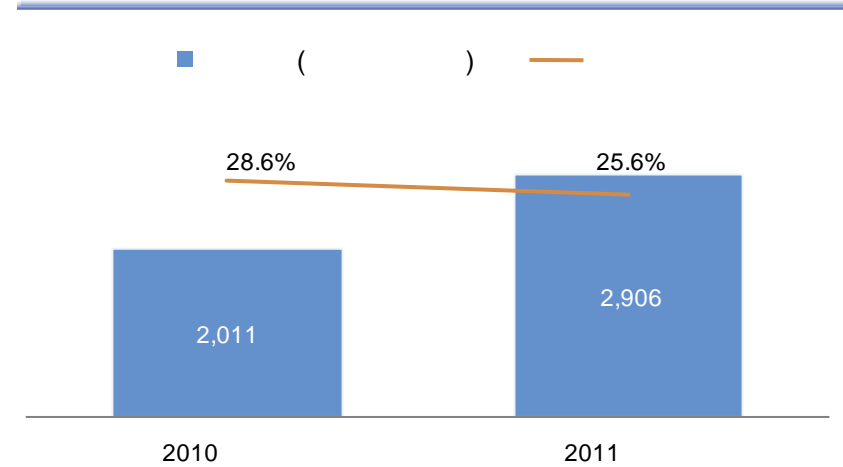

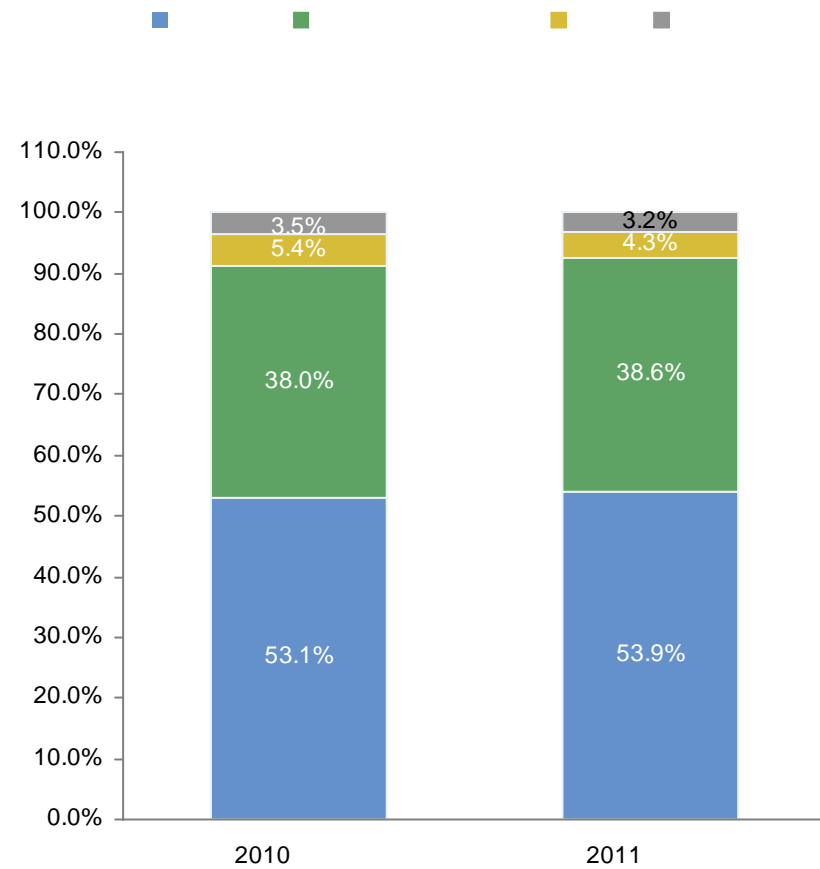
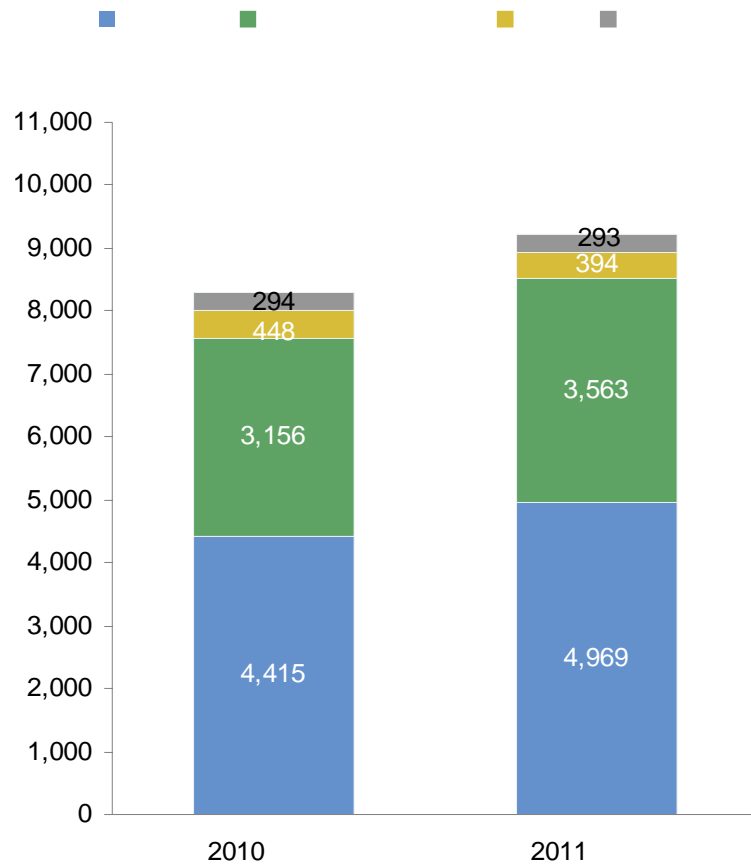

	2011	2010	(%)
	7,575	1,039	+ 629.1
(+)	20,089	9,586	+ 109.6
EBITDA / ()	30.9	43.3	- 12.4



1.

2.

3.

4.

5.

6.



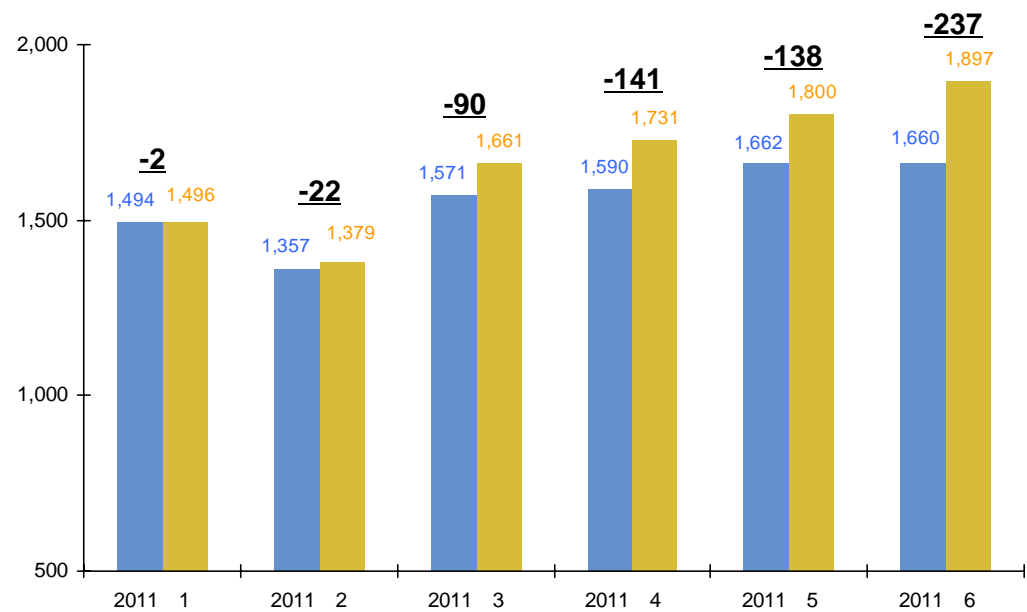
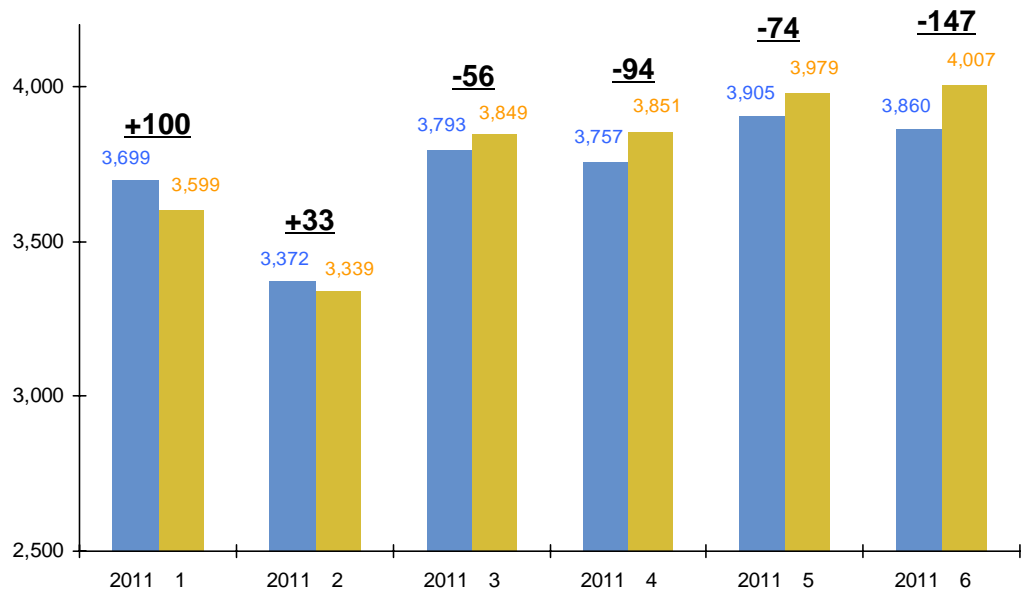

2011

(LME)

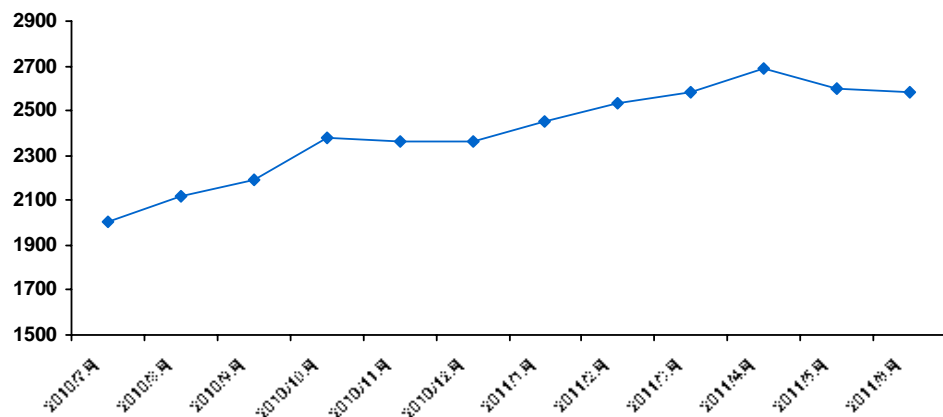

(SHFE)

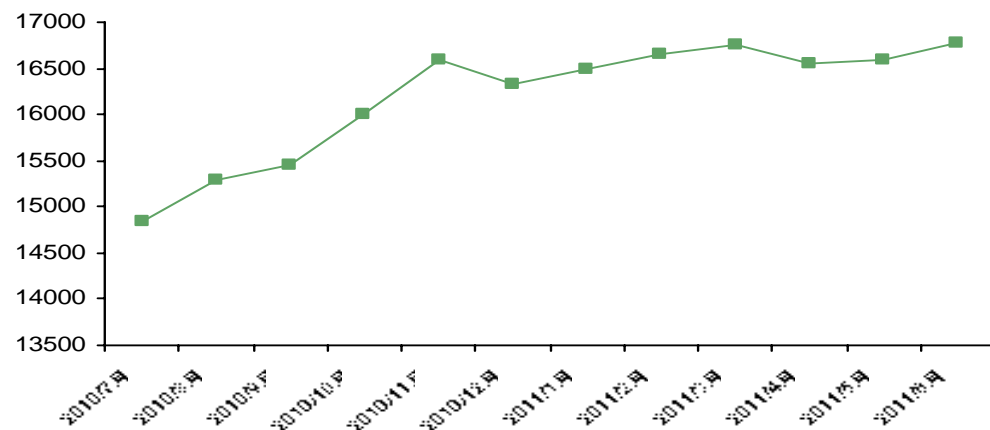

LME SHFE

2010

13,655

5.5%

14,405



2010

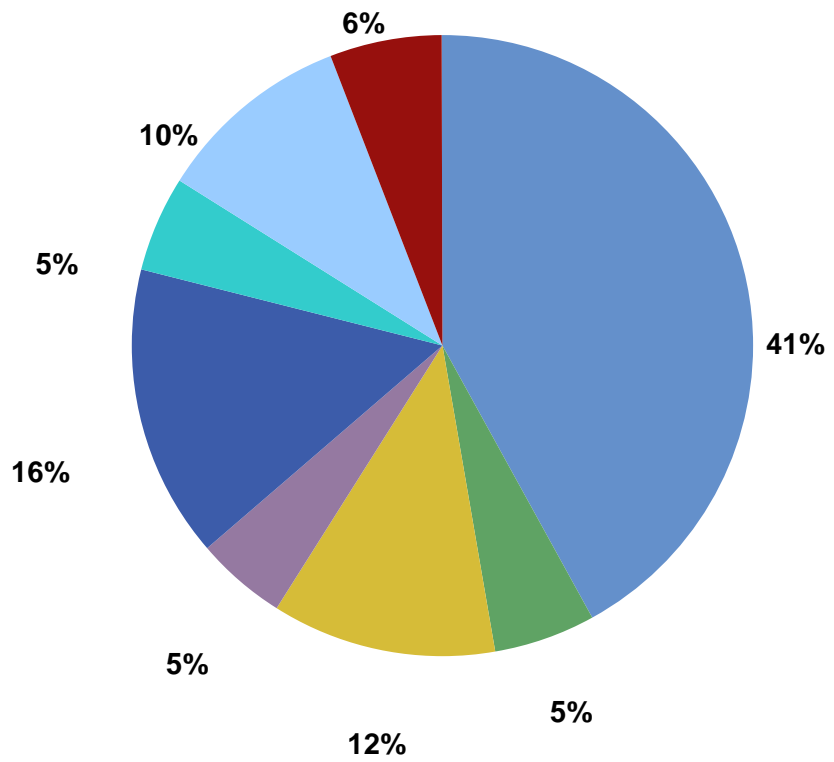

2010

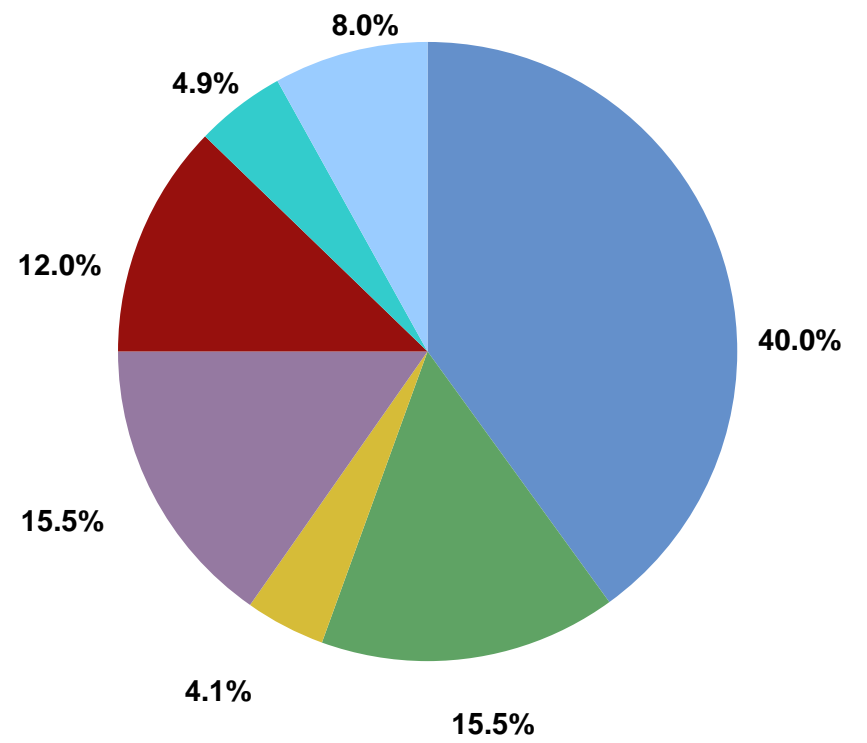

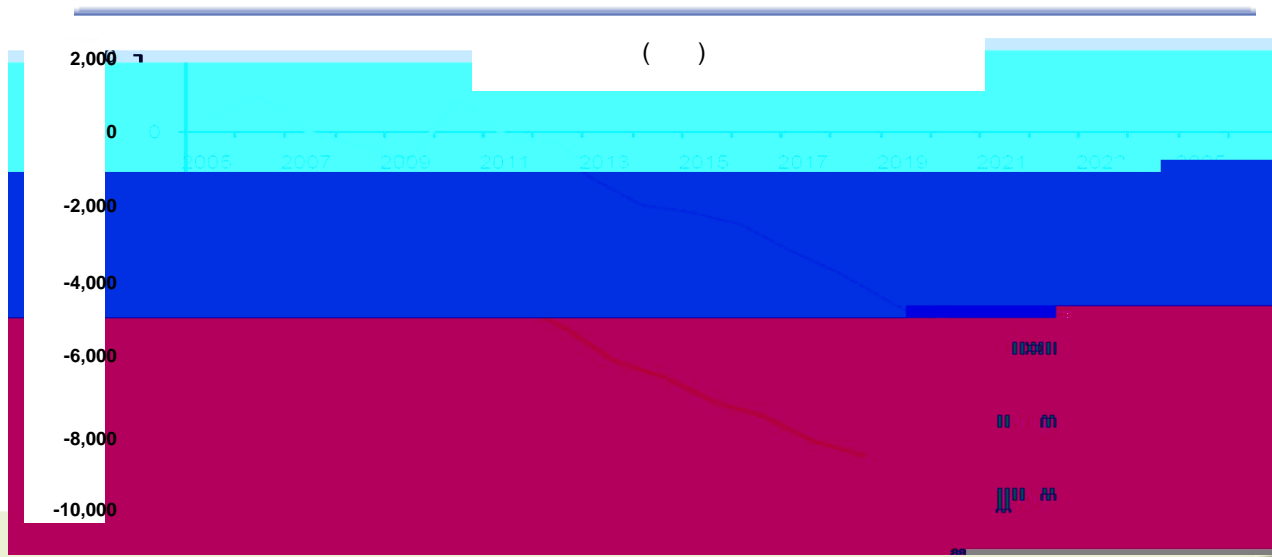
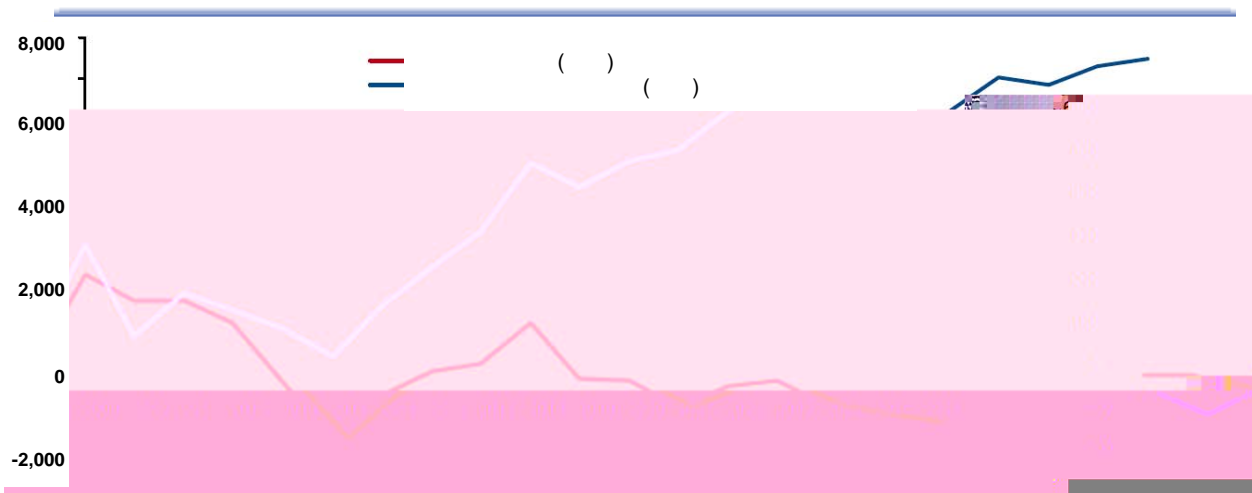

1.

2.

3.

4.

5.

6.



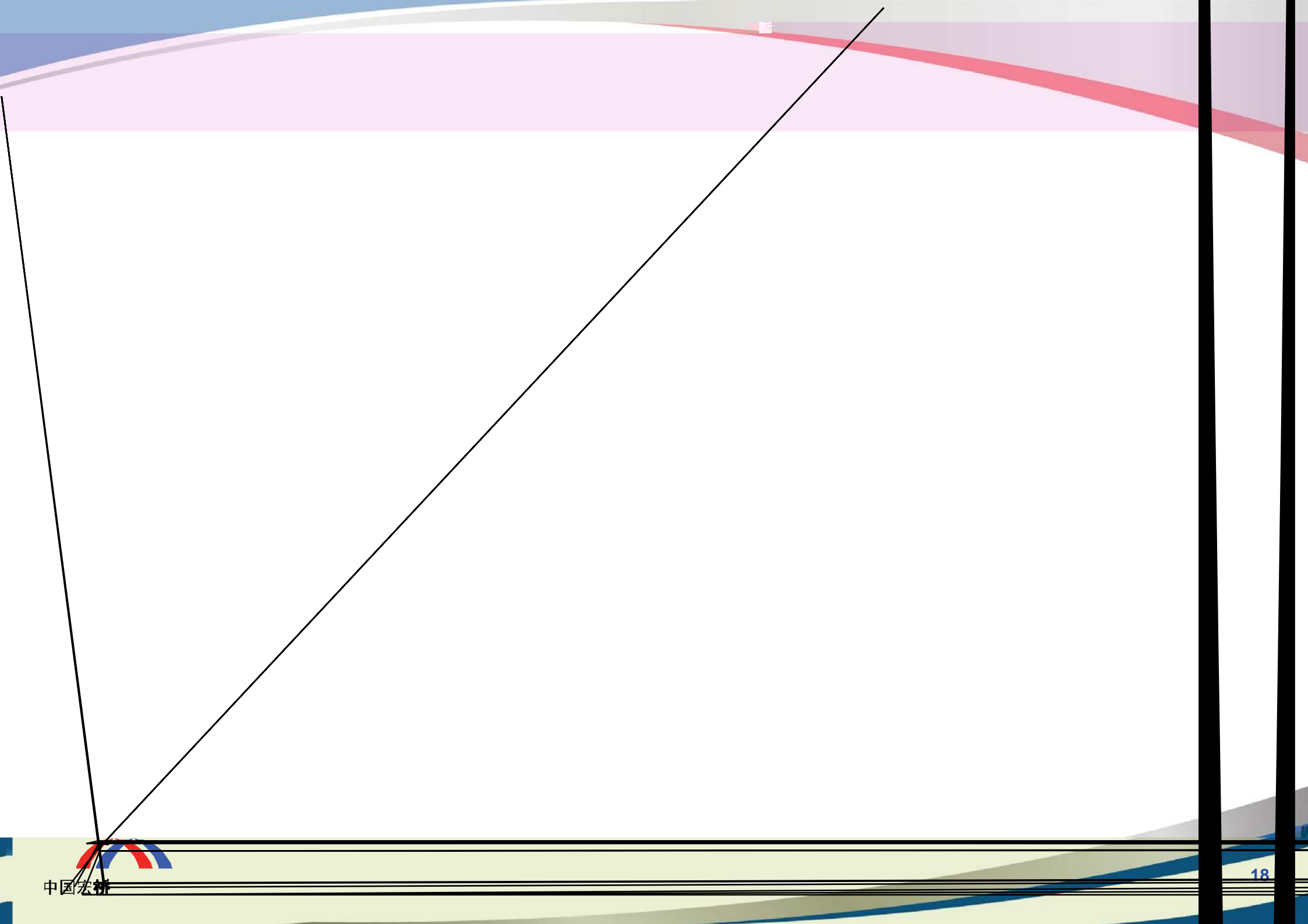

(/)

(/)

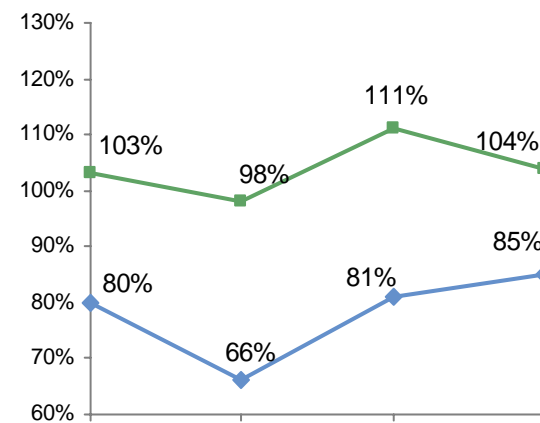



1,080

2011 0.22 / ,

2011 40.9%



0.29 ¹

2011 88

2,150 / , 26 / (), 16 / ²

¹ 5,000
² 2011

700 / 20%



1.

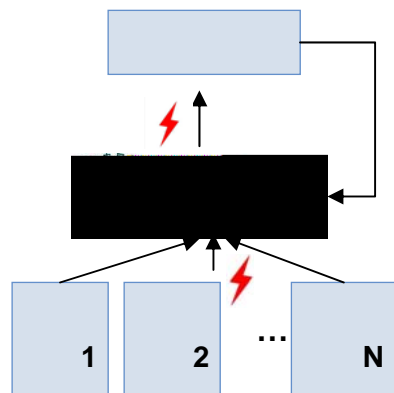

2.

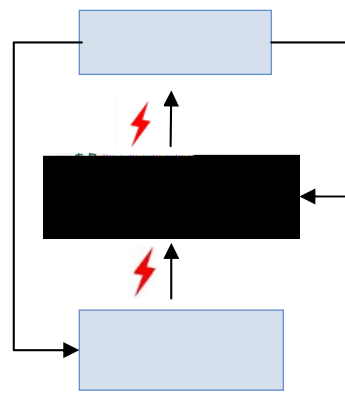

3.

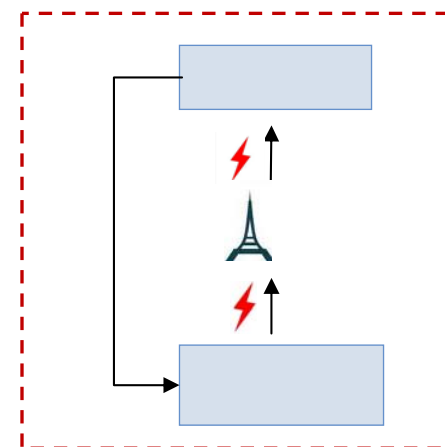

+

+

0.55¹

0.405¹ (0.15-0.20)

0.25-0.30¹





1.

2.

3.

4.

5.

6.



	2015		54.7%	9,435	1,887
		30			5.66
		37	2025	3.5	
		500	10% (50)		
	330				
	5	3,600	(1,000)	70	
	166				
	2010	1,826	127.5 /	145 /	
	12%	13%			
	2020		3,000	2020	
		150 /		450	2010
	235	1			
					4%



()

(MW)

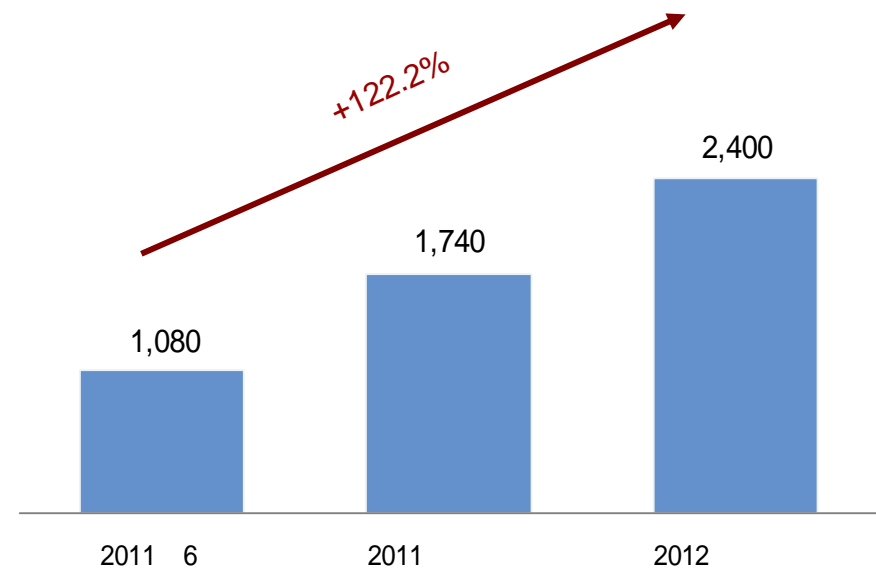
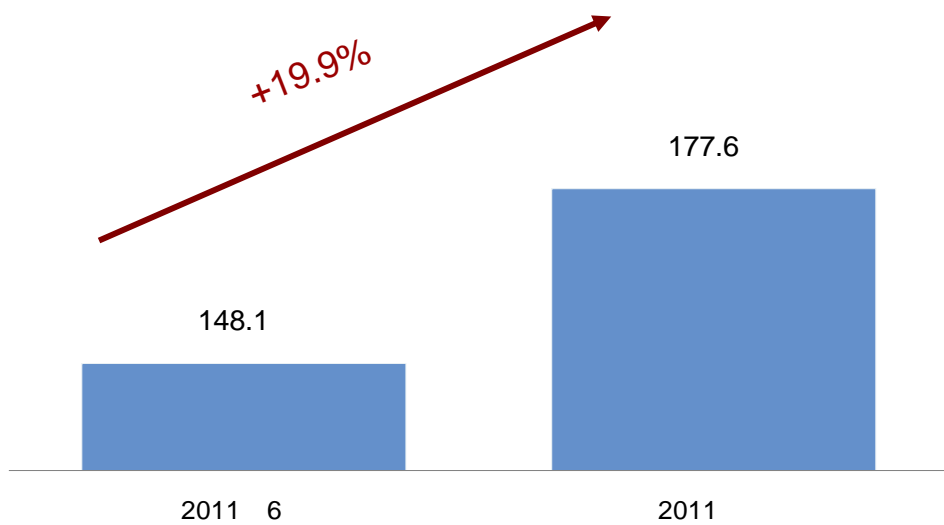

2011

30

4 x 330

3

46

38

178

65-70%





3 /

2012





中国宏桥集团有限公司

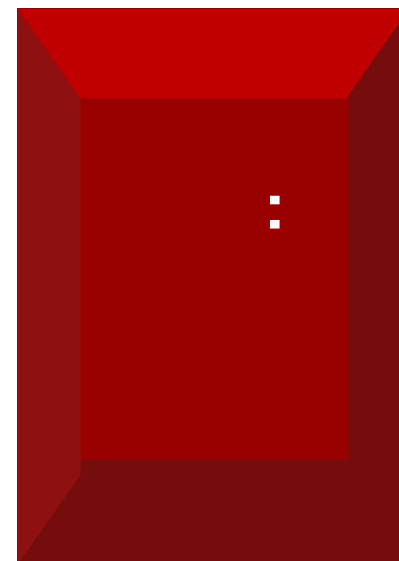

1.

2.

3.

4.

5.

6.

